







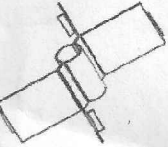
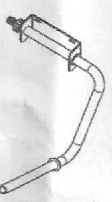

ASSEMBLY INSTRUCTION

TOOLS NEED: ADJUSTABLE WRENCH, SCREWDRIWER

No.	Parts Image&Desc.	Qty.
1	 Reel	2
2	 Cross Bars	4
3	 Spider	1
4	 Flow Tube Set	1
5	 Retaining Nuts Washers Bolts	8
6	 Wooden Handle Set	1
7	 Wall Anchors	4
8	 Black Bushes	2
9	 Brass Connector	1
10	 PTFE Tape	1

(1) Place one side of the reel flat side down protruded angles pointing upwards.
 (2) Attach 1 crossbar to the protruded side of the reel and ensure there is a washer either side of the nut and screw head. The nut should always be on the outside of the reel.
 (3) Insert the hooking claw at end of the spider through the rectangle slot on the crossbar. Always ensure the hooking claw on the spider does not protrude over the crossbar but is actually flat against the crossbar.
 (4) Repeat the above process on the remaining 3 crossbars.
 (5) Attach the second reel on top of the fitted cross bars ensuring there is a washer either side of the nut and screw head.

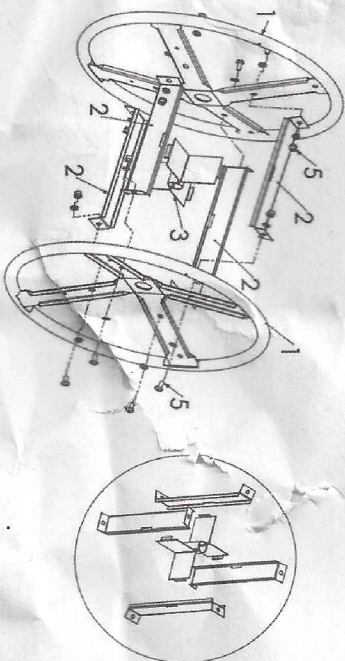

Please note: This instruction does not apply to pre-assembled reels.

(9) Assemble the wooden handle to the "Reel" as per following sketch.

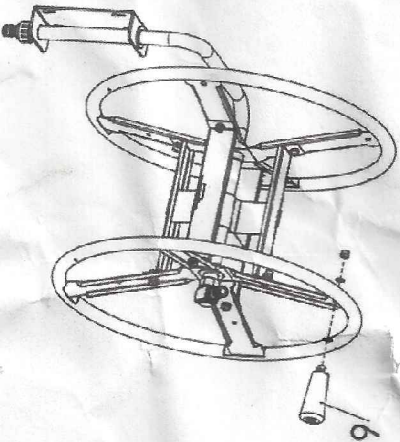

(6) Insert "black plastic bushing" into center holes of both two end of the "reel".
 (7) Seal the male thread end of the "Flow Tube" with "PTFE Tape".
 (8) Connect the "Brass Connector" to the male thread end of the above "Flow Tube".

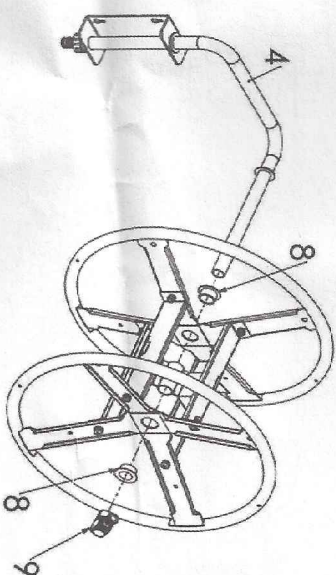

(10) Completes assembled hose reel use a 8mm (5/6") masonry drill bit.

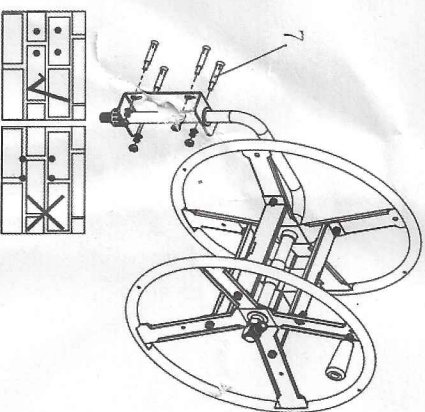

Important Warning

During the winter months please ensure the hose is disconnected from the brass connector.